

# PST-SERIES

# SUPER-TWEETER

## PST-535 (HIGH FREQUENCY SUPER TWEETER)

### GENERAL SPECIFICATIONS

Nominal Impedance	: 8	ohm
Frequency Range	: 6K~20K	Hz
Average Sensitivity (1w/1m)	: 112	dB
Power Capacity	: 75~300	Watts
Voice Coil Diameter	: 44.4	mm (1.75 in)
Disersion HxV	: 40°	
Polar Response-6dB	: 10K	Hz 40°H
Flux Density	: 1.6	T
Magnet	: Strontium Ferrite	
Diaphragm	: Titanium	
Voice Coil Materials	: Edge Wound Aluminium Wire	
Basket	: Cast Aluminium	
Net Weight	: 2.21	Kg (4.86Lb)
Dimension(H X W X D)	: 170mm X 130mm X 120mm 6.7in X 5.1in X 4.7in	

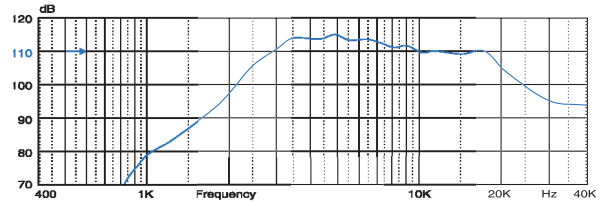
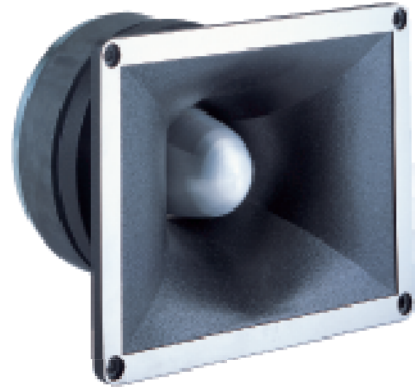
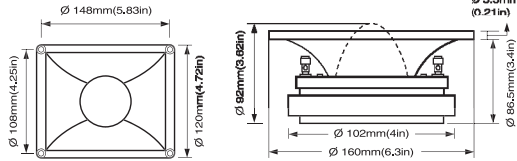

## PST-545 (HIGH FREQUENCY SUPER TWEETER)

### GENERAL SPECIFICATIONS

Nominal Impedance	: 8	ohm
Frequency Range	: 6K~20K	Hz
Average Sensitivity (1w/1m)	: 112	dB
Power Capacity	: 75~300	Watts
Voice Coil Diameter	: 44.4	mm (1.75 in)
Disersion HxV	: 40°	
Polar Response-6dB	: 10K	Hz 40°H
Flux Density	: 1.6	T
Magnet	: Strontium Ferrite	
Diaphragm	: Titanium	
Voice Coil Materials	: Edge Wound Aluminium Wire	
Basket	: Cast Aluminium	
Net Weight	: 2.13	Kg (4.68Lb)
Dimension(H X W X D)	: 130mm X 130mm X 100mm 5.1in X 5.1in X 3.9in	

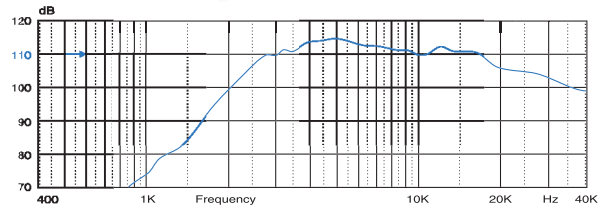
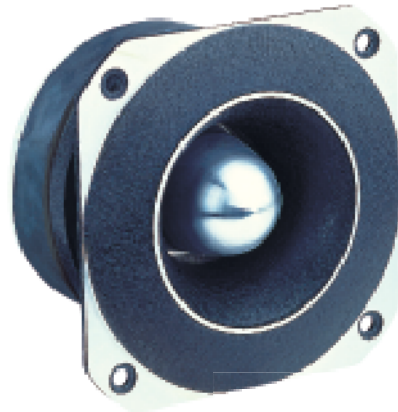
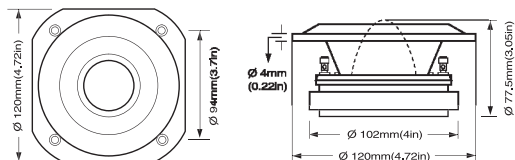

## PST-555 (HIGH FREQUENCY SUPER TWEETER)

### GENERAL SPECIFICATIONS

Nominal Impedance	: 8	ohm
Frequency Range	: 6K~20K	Hz
Average Sensitivity (1w/1m)	: 110	dB
Power Capacity	: 40~250	Watts
Voice Coil Diameter	: 37.5	mm (1.47 in)
Disersion HxV	: 40°	
Polar Response-6dB	: 10K	Hz 40°H
Flux Density	: 1.6	T
Magnet	: Strontium Ferrite	
Diaphragm	: Titanium	
Voice Coil Materials	: Edge Wound Aluminium Wire	
Basket	: Cast Aluminium	
Net Weight	: 1.72	Kg (3.78Lb)
Dimension(H X W X D)	: 115mm X 115mm X 95mm 4.5in X 4.5in X 3.7in	

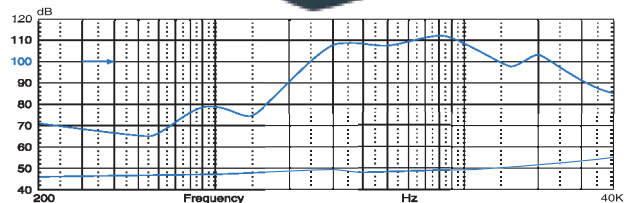
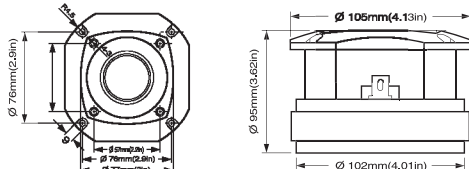

# PST-SERIES

# SUPER-TWEETER

## PST-777 (HIGH FREQUENCY SUPER TWEETER)

### GENERAL SPECIFICATIONS

Nominal Impedance	: 8	ohm	
D.C Resistance	: 6	ohm	
Frequency Range	: 3K~15K	Hz	
Average Sensitivity (1w/1m)	: 114	dB	
Power Capacity	: 75~300	Watts	
Voice Coil Diameter	: 72.2	mm	(2.84 in)
Magnet Weight	: 1.3	Kg	(45 oz)
Polar Response-6dB	: 15K	Hz	30°H
Magnet	: Strontium Ferrite		
Diaphragm	: Titanium		
Voice Coil Materials	: Edge Wound Aluminium Wire		
Basket	: Cast Aluminium		
Net Weight	: 5.4	Kg	(11.88Lb)
Dimension(H X W X D)	: 220mm X 190mm X 120mm 8.6in X 7.4in X 4.7in		

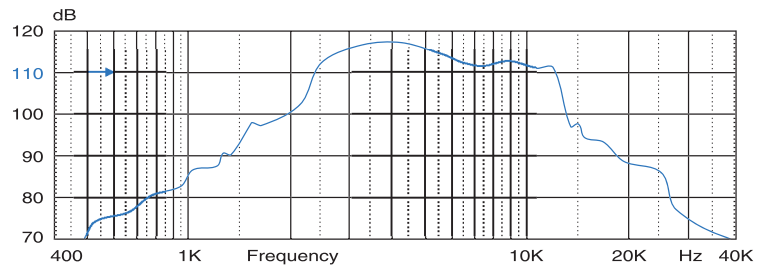
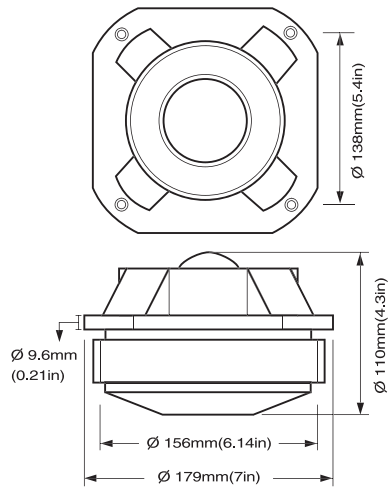
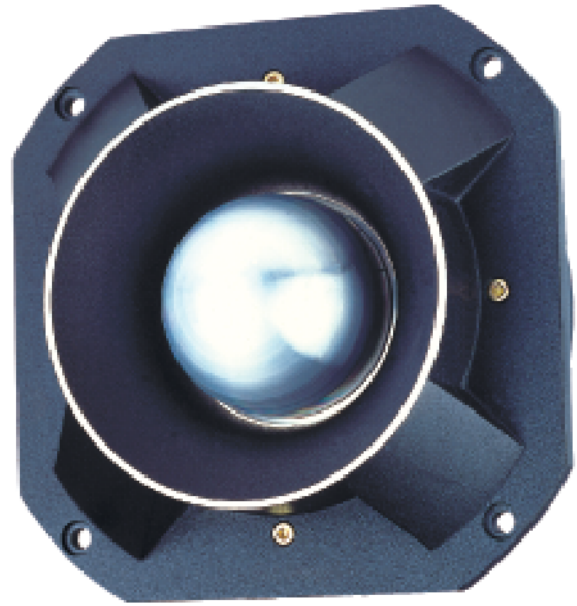

## PST-787 (HIGH FREQUENCY SUPER TWEETER)

### GENERAL SPECIFICATIONS

Nominal Impedance	: 8	ohm	
D.C Resistance	: 6	ohm	
Frequency Range	: 3K~15K	Hz	
Average Sensitivity (1w/1m)	: 114	dB	
Power Capacity	: 75~300	Watts	
Voice Coil Diameter	: 72.2	mm	(2.84 in)
Magnet Weight	: 1.3	Kg	(45 oz)
Disersion HxV	: 40°		
Polar Response-6dB	: 15K	Hz	30°H
Magnet	: Strontium Ferrite		
Diaphragm	: Titanium		
Voice Coil Materials	: Edge Wound Aluminium Wire		
Basket	: Cast Aluminium		
Net Weight	: 5.61	Kg	(12.34Lb)
Dimension(H X W X D)	: 190mm X 190mm X 140mm 7.4in X 7.4in X 5.5in		

